

LIFESAVER[®]

JERRYCAN

**FILTER
CLEAN
WATER**
instantly

**FILTER
OUT**
viruses,
bacteria, cysts &
parasites



**INVENTED,
DESIGNED
AND MANUFACTURED**
in Great Britain
Patented Worldwide

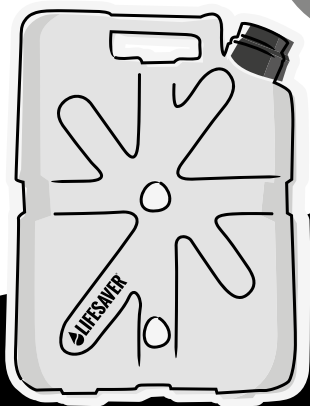

 The LifeSaver® Jerrycan filters out bacteria, viruses, cysts, parasites and fungi from water.

 LifeSaver water filters meet an adaption of NSF Protocol 231 based on recommendations of the U.S. Environmental Protection Agency (EPA). The LifeSaver Jerrycan filters bacteria to a minimum of Log 6 (99.9999%), viruses to a minimum of Log 4 (99.99%) and cysts to a minimum of Log 3 (99.9%).

 LifeSaver Jerrycan incorporates Failsafe™ technology - an automatic indicator of when the cartridge needs replacing. When the service life of the cartridge has been fulfilled, the filter stops passing water, taking away the guess work of knowing if your filter is still effective in filtering out contaminants.

CONTENTS

4	Priming the LifeSaver® Jerrycan
6	Routine use - after priming the LifeSaver® Jerrycan
9	Activated carbon filter
9	How to install a new activated carbon filter
10	Maintenance and Care
10	How to clean the Jerrycan
12	How to check for cartridge damage - membrane integrity check
13	How to install a new cartridge
15	Shelf life
16	Service life
17	Long-term storage - 1 month or more
18	Extreme temperatures
19	LifeSaver® technology
20	Performance and Technical Data
21	Frequently Asked Questions
22	Warranty
24	Contact us

IMPORTANT

Please read this manual before using the LifeSaver Jerrycan

PRIMING THE LIFESAVER® JERRYCAN

Priming is an essential step that must be performed within 3 years* from the date of manufacture and before you start to use the Jerrycan to drink from. The cartridge membranes are infused with glycerin during the manufacturing process to keep them hydrated up until the Jerrycan is primed. During priming you are flushing water through the cartridge, which removes this glycerin. Glycerin is a natural food source and whilst the presence of glycerin is not harmful, you should not drink the water used for priming the Jerrycan. It is imperative to follow the priming instructions to ensure that you flush all of the glycerin from the Jerrycan; this will mitigate the risk of bacteria forming on the output side of the cartridge.

*Except where foil wrapped cartridges are purchased.

IMPROVED FLOW RATE OF THE LIFESAVER® JERRYCAN OVER TIME

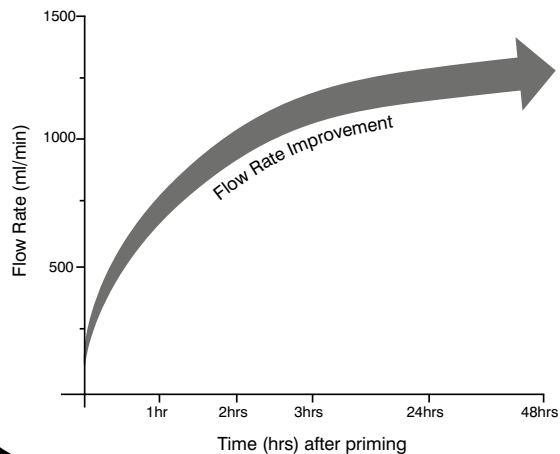

PRIMING - BEFORE FIRST USE



- 1 Unscrew and remove the pump from the Jerrycan. Completely fill the Jerrycan with clean water. Screw the pump firmly back into place and leave to stand for 10 minutes. After 10 minutes, pour the water away out of the pump hole.



- 2 Refill the Jerrycan and pump 10-15 times, turn the tap to the open position. After a short pause water will start to flow, you may need to re-pump the Jerrycan as the flow rate reduces. 5-10 pumps are all that is required to increase the flow rate. Lay the Jerrycan on its side (tap facing down) to encourage water to flow. This ensures the cartridge is completely submerged in water.



- 3 Allow approximately ½ of the water to pass through the tap and drain away, close the tap afterwards. Then dispose of the remaining water through the pump hole. The Jerrycan is now primed and ready for routine use.



- 4 If you're not using immediately, leave the Jerrycan full of clean water and allow to soak for a further 24-48 hours to achieve a faster flow rate.

IMPORTANT - Discard the water used in the soaking process to prevent bacteria growing in the glycerin water, which could prematurely block the cartridge.

ROUTINE USE - AFTER PRIMING THE LIFESAVER® JERRYCAN

After priming, fill the Jerrycan with water. Cleaner water will result in a faster flow rate and longer cartridge life. When filling the Jerrycan with water, keep the tap area clean and free from contamination.



- 1 Unscrew and remove the pump from the Jerrycan. Completely fill with water. The flow rate will be faster when the Jerrycan is full of water. Screw the pump back into place.



- 2 Ensure the tap is closed and pump 5-15 times.



- 3 Turn the tap to the open position* to enable clean drinking water to flow.



- 4 Continue to pump whilst the tap is open at a rate of approximately 1 pump per 3 seconds to maintain flow. Turn the tap off after use.

⚠ CAUTION

- *Keep the membranes of the cartridge in the Jerrycan hydrated by storing at least 1 inch/2.5cm of water in the Jerrycan at all times whilst keeping the Jerrycan sealed with the pump and tap in place. Failure to do so will cause the membranes to dry out, the nano-filter pores to close and the system will shut down. This is not covered under your warranty and you will need to purchase another cartridge (see page 16 for storage instructions).*
- *Do not pump if water is not flowing from the Jerrycan; this will over pressurise the Jerrycan, which will result in the product becoming stressed. To release pressure from the Jerrycan unscrew the pump slowly by ¼ of a turn until you hear a hiss sound. Hold on to the pump firmly whilst unscrewing.*
- *Do not operate the pump whilst the Jerrycan is empty.*

💧 HELPFUL TIPS

- *The flow rate will be faster when the Jerrycan is full of water.*
- *The flow rate will be faster when the Jerrycan is used with warmer water, therefore glacier melt water will slow the flow.*
- *The Jerrycan is designed to work in both the horizontal and vertical position. As the water level becomes low, lay the Jerrycan on its side, with the tap facing downwards. This method will increase water flow.*

* To open the tap either:

- *Push down on the tap for an instant flow of water.*
- *Twist the tap clockwise and lock into position for a continuous flow of water. To release the tap from the lock twist anti-clockwise to return the tap to the closed position.*

USING YOUR BOTTLE THE CUT AWAY OF THE LIFESAVER® JERRYCAN

Carry handle

Tap

Tap protection housing

Tap outlet that LifeSaver shower attachment can be fitted to

Activated carbon filter

Pump handle

Removable pump for easy filling

Replacable LifeSaver ultra filtration (UF) cartridge

Connection apertures for bolting to vehicles

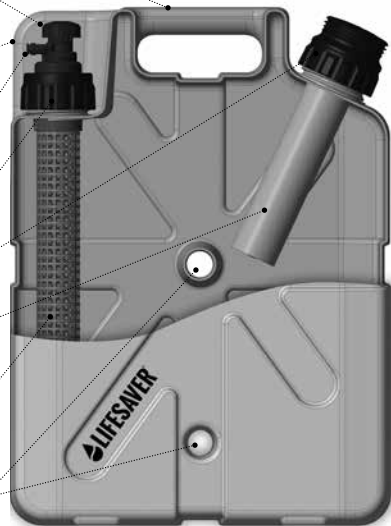

ACTIVATED CARBON FILTER

How to install a new activated carbon filter

The high specification activated carbon block will improve the palatability of water by removing chlorine, taste and odour.

- Unscrew and remove the tap from the Jerrycan.
- Using the removal tool create a hole in the middle of the activated carbon filter by twisting the tool clockwise and anti-clockwise whilst applying a small amount of force. **1**
- Continue to screw the tool clockwise into the centre of the carbon filter until all available thread of the removal tool is within the carbon filter. **2**
- Using a sharp pulling motion remove the carbon filter from the Jerrycan tap.
- Insert a new activated carbon filter into the tap and rescrew the tap onto the Jerrycan.

When fitted, you may notice that the water flowing out of the Jerrycan contains grey/black particles. This is harmless carbon dust and once the activated carbon filter has been used 2-3 times, this will disappear.

1

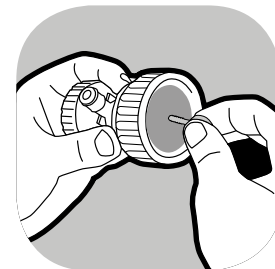

2

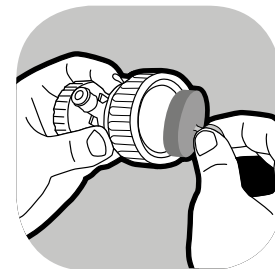

⚠ CAUTION

Leaving the activated carbon filter inside the Jerrycan whilst in long-term storage may cause microbiological growth to occur. Always remove and discard the activated carbon filter when storing the Jerrycan long term.

1

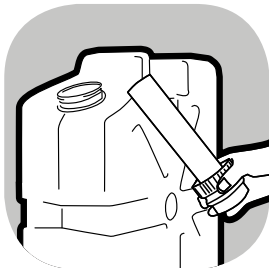

2



3



MAINTENANCE AND CARE

Over the life of the cartridge, dirt and debris will build up on its surface. To reduce this build-up, clean the Jerrycan on a regular basis.

How to clean the Jerrycan, whilst outdoors

- With the tap in the closed position, unscrew and remove the pump. 1
- Fill the Jerrycan with 2 litres of the cleanest water available and swirl around the Jerrycan to remove large pieces of debris and dirt lying at the bottom of the Jerrycan. Empty the water through the pump hole. 2
- Refill the Jerrycan ¼ full with the cleanest water available and re-fit the pump. 2
- Continue to swirl the water around the Jerrycan, turning the Jerrycan upside down to distribute the water around the Jerrycan. Continue up to 1 minute.
- Unscrew and remove the pump and empty the water through the pump hole. 3
- Repeat this process until the water being tipped away is visibly clean.

▲ CAUTION

Do not attempt to touch the membranes of the cartridge through the protective mesh as this can cause damage and will void your warranty. Keep the cartridge free from dirt and debris.

How to clean the Jerrycan, whilst indoors in a clean environment

- Unscrew and remove the pump.
- Unscrew and remove the tap and cap. 1
- Remove the cartridge from the Jerrycan by prising under the flange (the lip of the cartridge). Remove the o-ring from the top of the cartridge and put it to one side.
- Place the protective cap provided over the end of the cartridge; this will prevent contaminated water from entering the clean water area of the cartridge during cleaning. 2
- Soak the cartridge in a basin of warm water for 30 minutes. Gently move the cartridge through the water to dislodge any dirt or debris. Hold one hand over the protective cap to prevent the cap from falling off whilst moving the cartridge through the water.
- Rinse the cartridge with clean running water and leave to drain for 4 hours. 3
- Whilst the cartridge is draining, wash all of the plastic components including the o-ring with a mild detergent solution in warm water using a soft cloth. Rinse the components thoroughly under running water and drain for 1 hour.
- Refit the o-ring to the top of the cartridge. Ensure that it is positioned tightly against the flange (lip) of the cartridge.
- Insert the cartridge into the Jerrycan and press down to fix into place.
- Wipe the face of the cartridge with a sterile wipe or clean cloth to clean any contamination from the clean face.
- Fit the tap cap and ensure it is tightened firmly with the top facing straight forward.

1

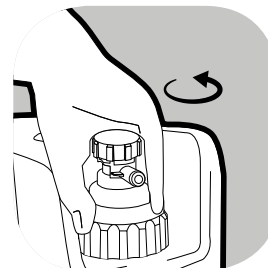

2

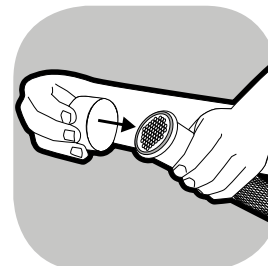

3



How to check for cartridge damage

The ultra filtration membranes have been integrated into a robust cartridge and have been designed for a long service life. However, if treated incorrectly the cartridge is liable to break.

The membrane integrity check should be performed every time the Jerrycan has been subjected to shock or when you suspect damage may have occurred to the Jerrycan cartridge.

⚠ CAUTION

Do not subject the Jerrycan to shock or misuse the Jerrycan by inserting objects into the cartridge.

1

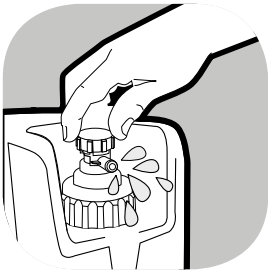

Membrane integrity check

- Unscrew and remove the pump from the Jerrycan. Half fill the Jerrycan with water. Screw the pump back into place.
- Ensure the tap is closed and pump 30-40 times to pressurise the Jerrycan.
- Turn the tap to open position to enable water to flow.
- Continue to pump whilst the tap is open at a rate of approximately 1 pump per 3 seconds to drain the Jerrycan of all of its water. As the water level gets low you may need to lay the Jerrycan down.
- If the Jerrycan spits water from the tap **1** and does not flow freely then air is being expelled from the tap along with water. This means that the cartridge is damaged. Stop using the Jerrycan and replace the cartridge (see page 13 for how to install a new cartridge).
- If water isn't spitting from the Jerrycan, but water flow is slower than normal despite the Jerrycan being ½ full at either the horizontal or vertical position, clean the Jerrycan as dirt and debris maybe causing slower water flow. If the Jerrycan has been cleaned and water flow remains slower than normal, the cartridge may be reaching the end of its life (see page 19 for Failsafe technology).

How to install a new cartridge

- Unscrew and remove the pump from the Jerrycan and empty the Jerrycan of any water.
- Unscrew and remove the tap cap and tap.
- Remove the cartridge from the Jerrycan by prising under the flange (the lip of the cartridge) and discard as recyclable plastic waste.
- Once the cartridge is removed wash all of the plastic components including the white flat seal (found under the pump handle) in warm water with a mild detergent solution using a soft cloth. Rinse thoroughly under running water and leave to drain for 1 hour.
- Remove the new cartridge from its packaging and ensure that the two o-rings are positioned tightly against the flange (lip) of the cartridge. **1** Insert the new cartridge into the Jerrycan and press down to fix into place.
- Screw the tap onto the Jerrycan. Ensure that the tap cap is tightened firmly with the tap facing straight forward. **2**
- You are now ready to prime the cartridge (see page 5 for priming – before first use).

Installing a new cartridge whilst outdoors causes a heightened risk of cross contamination. When changing the cartridge ensure you have clean, dry hands and the tap and cartridge remain sterile.

1

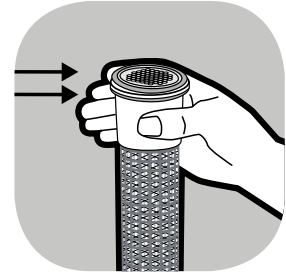

2

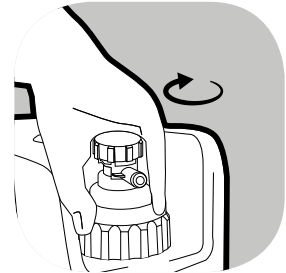

1

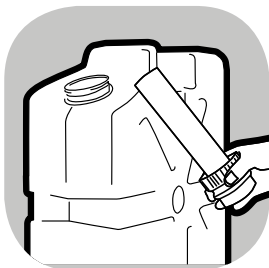

How to clean the dome valve

The dome valve allows the pump to work effectively and will require cleaning from time to time.

- Unscrew and remove the pump from the Jerrycan. 1
- Remove the black dome valve, which is located at the end of the pump by prying under the outer edge of the valve to remove. 2
- Wash the dome valve in warm water with a mild detergent solution to remove any contaminants.
- Rinse thoroughly with running water and leave to drain for 1 hour.
- Replace the dome valve in the end of the pump by aligning centrally and pushing the valve back into place.

2

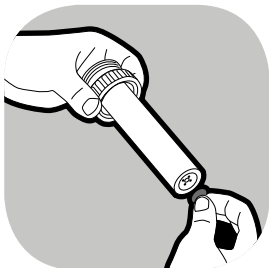

SHELF LIFE

Standard packaged cartridge

The Jerrycan can be stored unused for up to 3 years from the date of manufacture. Priming is an essential step that must be performed within 3 years from the date of manufacture and before you start to use the Jerrycan to drink from.

If stored longer than 3 years the Jerrycan membranes will dry out, causing the membranes pores to close and the system to shut down.

Aluminium barrier foil, heat sealed cartridge

An aluminium foil, heat sealed cartridge provides the lowest moisture transition rate available. This protection means that if sealed in the condition it was purchased the shelf life of the product can be extended up to 10 years from the date of manufacture.

Standard packaged activated carbon filter

An activated carbon filter, if sealed in its original polythene wrapping, can be stored for approximately 3 years from the date of manufacture subject to storage conditions. If left unsealed the activated carbon filter can be stored for up to 2 months before expiry. Carbon is a natural absorbent, so if left unsealed it will be absorbing all pollutants in the air around it.

Aluminium barrier foil, heat sealed activated carbon filter

An aluminium foil, heat sealed carbon filter provides the lowest moisture transition rate available. This protection means that if sealed in the condition it was purchased the shelf life of the product can be extended up to 10 years from the date of manufacture. On opening of the foil sealed packaging, the activated carbon filter can be stored for 3 years if sealed in the zip lock foil bag it was supplied in.

SERVICE LIFE

Cartridge

In ideal conditions the cartridge will process the number of litres specified. As an example the 10,000 litre cartridge will last approximately 9 years. This is based on the user filtering 3 litres per day; as per the WHO guidelines for drinking water recommendations *

Activated carbon filter

Each activated carbon filter will process 500 litres of water. If the Jerrycan is used to process 3 litres of water per day, each activated carbon filter will last approximately 5 months before a replacement activated carbon filter is required.

*These are approximate life spans dependent on the water sources being used and the cartridge in the Jerrycan being kept hydrated as per the storage instructions and well maintained as per the maintenance and care instructions.

STORAGE

The Jerrycan

Before first use, the Jerrycan should be kept in a cool, dry place. After first use, always store the Jerrycan in a cool place when not in use, ideally between 5-20°C. Protect the Jerrycan against extreme temperatures outside of this range.

Keep the membranes of the cartridge hydrated by storing at least 1 inch/2.5 cm of water in the Jerrycan at all times whilst keeping the Jerrycan sealed with the pump and tap in place. Failure to do so will cause the membranes to dry out, the nano-filter pores to close and the system to shut down. This is not covered under your warranty and you will need to purchase another cartridge.

To ensure the Jerrycan remains in the best condition use on a regular basis.

Activated carbon filter

After opening a pack of activated carbon filters ensure that you store the additional, spare activated carbon filters within the foil zip lock bag or within a sealed container. This will preserve their shelf life for up to 3 years. If left unsealed, the activated carbon filters will expire within 2 months.

When storing the Jerrycan for a period of 1 month or more, the activated carbon filter should be removed and discarded. Replace with a new carbon filter before next use.

LONG-TERM STORAGE - 1 MONTH OR MORE

Before storing the Jerrycan:

- Remove and discard the activated carbon filter from the Jerrycan and clean the Jerrycan (see page 10 for how to clean the Jerrycan).
- Release pressure from the Jerrycan by unscrewing the pump slowly by $\frac{1}{4}$ turn until you hear a hiss sound. Hold on to the pump firmly whilst unscrewing. After pressure is released screw the pump back into place.
- Store at least 1 inch/2.5cm of water in the Jerrycan at all times.
- Ensure the pump and tap are sealed.

Before re-using the Jerrycan:

- Clean the Jerrycan before re-use (see page 10 for how to clean the Jerrycan).
- Fit a new activated carbon filter before re-use (see page 9 for how to install an activated carbon filter).

How to prevent hardness salts building up on the cartridge during long-term storage

Prolonged storage in areas of hard water will result in the crystallization of calcium, magnesium and salts on and within the membranes of the cartridge. To prevent this from happening, keep the membranes of the cartridge in the Jerrycan hydrated by storing at least 1 inch/2.5cm of water in the Jerrycan at all times whilst keeping the Jerrycan sealed with the pump and tap in place. Failure to do so will cause the membranes to dry out, the nano-filter pores to close and the system to shut down. This is not covered under your warranty and you will need to purchase another cartridge.

1

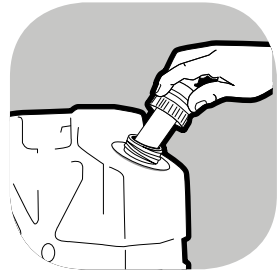

EXTREME TEMPERATURES

Cold temperatures

After first use the Jerrycan should be protected from freezing. Freezing can compromise the integrity of the cartridge. If you suspect the Jerrycan has been frozen, perform a membrane integrity check, page 12.

Hot temperatures

Do not leave the Jerrycan in direct sunlight for long periods of time.

2



For minimum and maximum operating and storage temperatures refer to Performance and Technical data, page 20.

Transporting your LifeSaver Jerrycan

When taking the Jerrycan on an aeroplane ensure that you:

- Release pressure from the Jerrycan by unscrewing the pump slowly by ¼ turn until you hear a hiss sound. Hold on to the pump firmly whilst unscrewing. 1
- Remove the pump and completely drain the Jerrycan of water. 2
- After draining the Jerrycan screw the pump back into place.
- Ensure the pump and cap are correctly sealed. 3
- Pack the Jerrycan securely in the hold or within hand luggage.
- Pour 1 inch/2.5 cm of water into the Jerrycan when the destination is reached.
- Perform a membrane integrity check before re-use (see page 12).

3

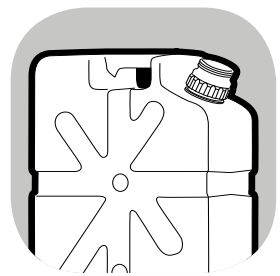

FAILSAFE™ TECHNOLOGY

The Jerrycan incorporates Failsafe™ technology - an automatic indicator of when the cartridge needs replacing. When the service life of the cartridge has been fulfilled, the pores in the membranes will be blocked by contaminants. The filter stops passing water taking away the guess work of knowing whether your filter is still effective in filtering out contaminants. At this point you should replace your cartridge.

As the cartridge reaches the end of its life, a greater number of pumps are required to induce water flow. 1 There will come a point at which despite the recommended maximum number of pumps water does not flow. Before you install a new cartridge, check:

- The level of water in the Jerrycan. As the water level becomes low, flow rate will reduce.
- Clean the Jerrycan as the cartridge may be covered in dirt and debris causing flow rate to be reduced (see page 10 for how to clean the Jerrycan).

1



PERFORMANCE DATA

Minimum operating temperature	>0°C (32°F)
Maximum operating temperature	50°C (122°F)
Minimum storage temperature *	-10°C* (14°F)
Maximum storage temperature	50°C (122°F)
Initial flow rate**	10,000 litres (3L/min @ 0.6 Bar (g)) 15,000 litres (3.5L/min @ 0.6 Bar (g)) 20,000 litres (4L/min @ 0.6 Bar (g))
Cartridge service rating**	10,000 litres (2650 US gallons) 15,000 litres (3975 US gallons) 20,000 litres (5300 US gallons)
Dry weight of Jerrycan inc. cartridge	3.9kg (137 oz)
Jerrycan storage capacity	18.5L (625 US oz)
Product materials and water effluent BPA and BPS free	

MICROBIOLOGICAL FILTRATION EFFICACY

Bacteria retention***	>99.9999 % (Log 6)
Virus retention***	>99.99 % (Log 4)
Cyst reduction***	>99.998% (Log 4.7)
Chemical reduction	Optional activated carbon filter improves the palatability of water by removing chlorine, taste and odour from water.

LIFESAVER JERRYCAN TEST COMPLIANCE

Testing is based on a suitable adaption of NSF/ANSI P231. These units are tested with two different types of water to challenge the filtration capability beyond the standard use. All figures quoted are taken from the stressed challenge phase of the test imitating sewage contaminated water.

* After first use the product should be protected against freezing

** Flow rates and service rating dependant on the composition, temperature and turbidity of the feed water

*** Tested by BCS laboratories issued 09/02/16 based on an adaption of NSF/ANSI P231 Protocol

FAQ'S

Q. Where do I purchase additional cartridges & replacement parts?

A. Replacement cartridges and accessories are available for purchase from www.iconlifesaver.com

Q. Where do I dispose of spent cartridges?

A. The cartridge is made of recyclable plastic and should be disposed of at a recycling centre. If this is not possible, you can dispose of it in your normal household waste.

Q. What are the dimensions of the LifeSaver Jerrycan?

A. LifeSaver Jerrycan is approximately 470mm in height, 340mm in width and 170mm in depth.

Q. I am pumping but no water is coming out

A. Your cartridge may have expired or may require cleaning. (See page 12 for how to perform a membrane integrity check).

Q. Does the LifeSaver Jerrycan filter sea water?

A. No. The LifeSaver Jerrycan will remove all microbiological contamination from sea water; however it does not filter the salt from the sea water or any other salts from water.

Q. Could the LifeSaver Jerrycan be used to filter and drink urine?

A. You can filter urine with the LifeSaver Jerrycan and it will remove all the microbiological contamination however as there is a certain amount of salt in urine the resulting water will have a level of salt dissolved into it that the LifeSaver Jerrycan will not remove. This will increase as the urine is repeatedly filtered.

We suggest you could potentially do this up to 4 times before the salt levels become dangerous; however it is recommended that you seek alternate water sources before using the LifeSaver Jerrycan this way.

Q. Can the LifeSaver Jerrycan remove other liquids apart from water?

A. The LifeSaver Jerrycan is designed to filter water only. It is not designed for filtering sugared or carbonated drinks, alcohol or any other liquids.

INTERNATIONAL LIMITED WARRANTY:

Thanks again for purchasing a LifeSaver Jerrycan. If you have any questions relating to this or any other product in our range please contact us via our website where we will be more than happy to help.

If purchased from Icon Lifesaver Ltd directly or an authorised LifeSaver reseller the LifeSaver Jerrycan comes with a 2 year international warranty from the date of purchase against defects in materials and workmanship. Should your LifeSaver Jerrycan prove defective within 2 years from the date of purchase you should return it to the retailer that you originally purchased it from. Icon Lifesaver Ltd will, at its sole discretion, repair or replace the damaged item(s).

You should ensure that you retain your proof of purchase showing the date on which you purchased your LifeSaver Jerrycan. Without it we are unable to offer warranty assistance. This International Limited Warranty does not affect your statutory legal rights.

The warranty is non-transferable and does not apply to second hand purchases.

DISCLAIMER

The information and data contained in this document are based on our general experience and are believed to be correct. They are given in good faith and are intended to provide a guideline for the selection and use of our products. Since the conditions under which our product may be used are beyond our control, this information does not imply any guarantee of final product performance and we cannot accept any liability with respect to the use of our products. The quality of our products is guaranteed under our conditions of sale. Existing industrial property rights must be observed.

© 2017 Icon LifeSaver Ltd. All Rights Reserved. Patents registered designs pending and granted. LifeSaver is a registered trade mark. The following are trademarks of the LifeSaver group of companies: For A Hostile World™, Fill•Pump•Drink™ and Failsafe™.

All details given on and in this manual are believed to be correct at the time of going to press. We reserve the right to make improvements and/or modifications to the equipment herein.

CONTACT US

Icon LifeSaver Ltd
Hall Chase, London Road
Marks Tey, Colchester
CO6 1EH, UK

w: www.iconlifesaver.com

t: +44(0)1206 580999

e: info@iconlifesaver.com

